

Aankruisen/invullen wat van toepassing is. Een type per formulier.

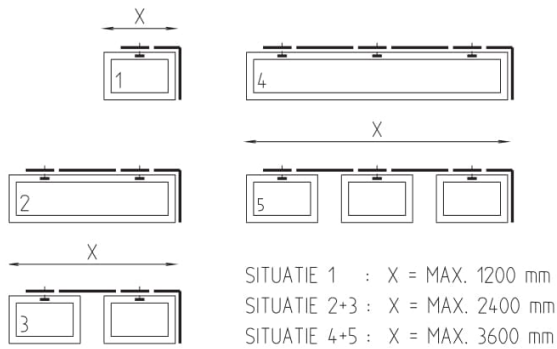

Aantal :	stuks	Maten :			
<input type="checkbox"/> Blank geanodiseerd	<input type="checkbox"/> RAL 9016	A	mm		
Situatie :		B	mm		
<input type="checkbox"/> 1	<input type="checkbox"/> 2	<input type="checkbox"/> 3	<input type="checkbox"/> 4	<input type="checkbox"/> 5	
Type :		C	mm		
<input type="checkbox"/> A	<input type="checkbox"/> B	<input type="checkbox"/> C	<input type="checkbox"/> D	<input type="checkbox"/> E	<input type="checkbox"/> F
Bediening :		D	mm		
<input type="checkbox"/> H	<input type="checkbox"/> HD	<input type="checkbox"/> W1	<input type="checkbox"/> W2		
..... x 173 128 0	..... x 173 121 3	E	mm		
		F	mm		
		G	mm		
		H	mm		
		K 1	mm		
		K 2	mm		

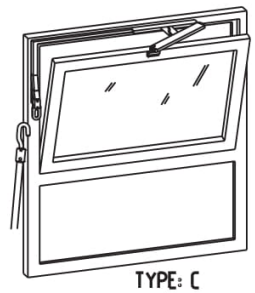
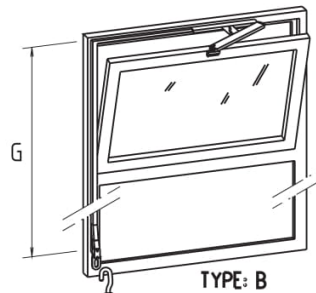
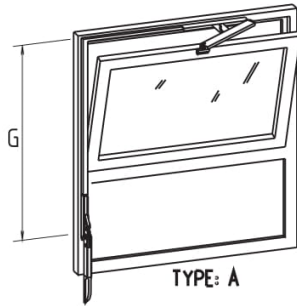
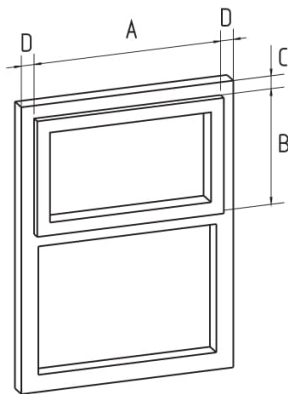

AFWIJKENDE DETAILS  
 KUNNEN AAN DE  
 ACHTERZIJDE VAN  
 DIT FORMULIER  
 WORDEN GESCHETST.

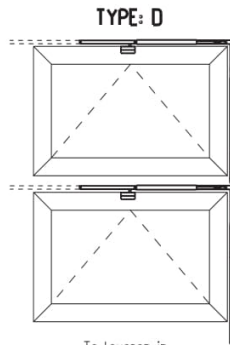
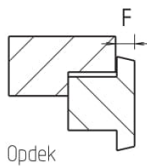

Te leveren in  
 combinatie met  
 TYPE A, B, E, F.

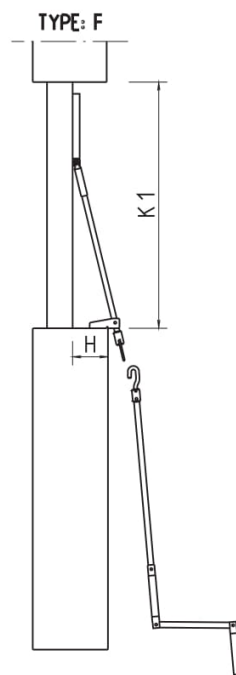
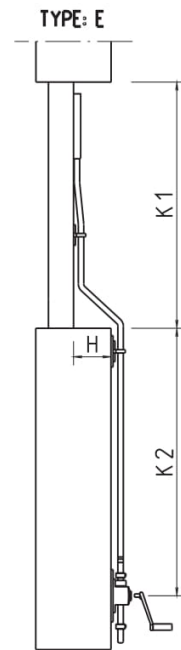
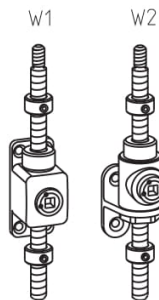
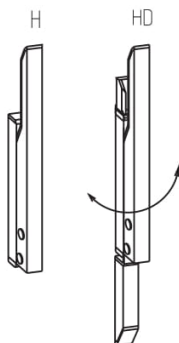

SLINGER  
 KODENR. 173 128 0

SLINGER L = 3000MM  
 KODENR. 173 121 3

Opgave betreft : <input type="checkbox"/> Aanvraag <input type="checkbox"/> Opdracht	
van : ..... ..... .....	verzendadres : ..... ..... .....

